

SEZIONE TIPO - PARTICOLARE INGHISAGGIO PILASTRI E MURI DI RINFORZO  
SCALA 1:20

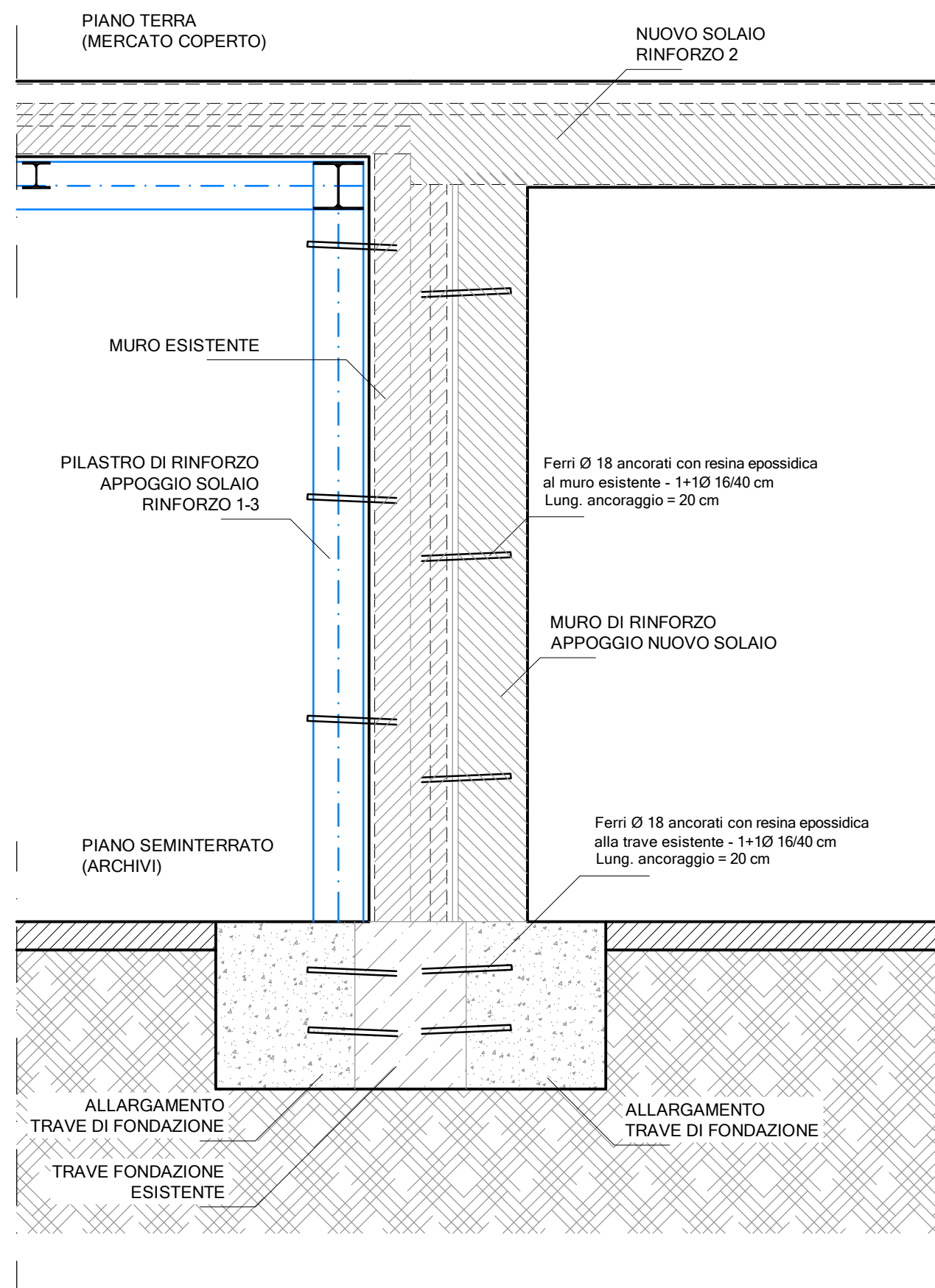

Pianta seminterrato - ARCHIVIO 02 - Nuovo solaio - Rinforzo 2

Carpenteria Piano 1 (Scala 1:50)

Legenda:

= Rete elettrosaldata

= Cordolo rompitratta 25 X 12

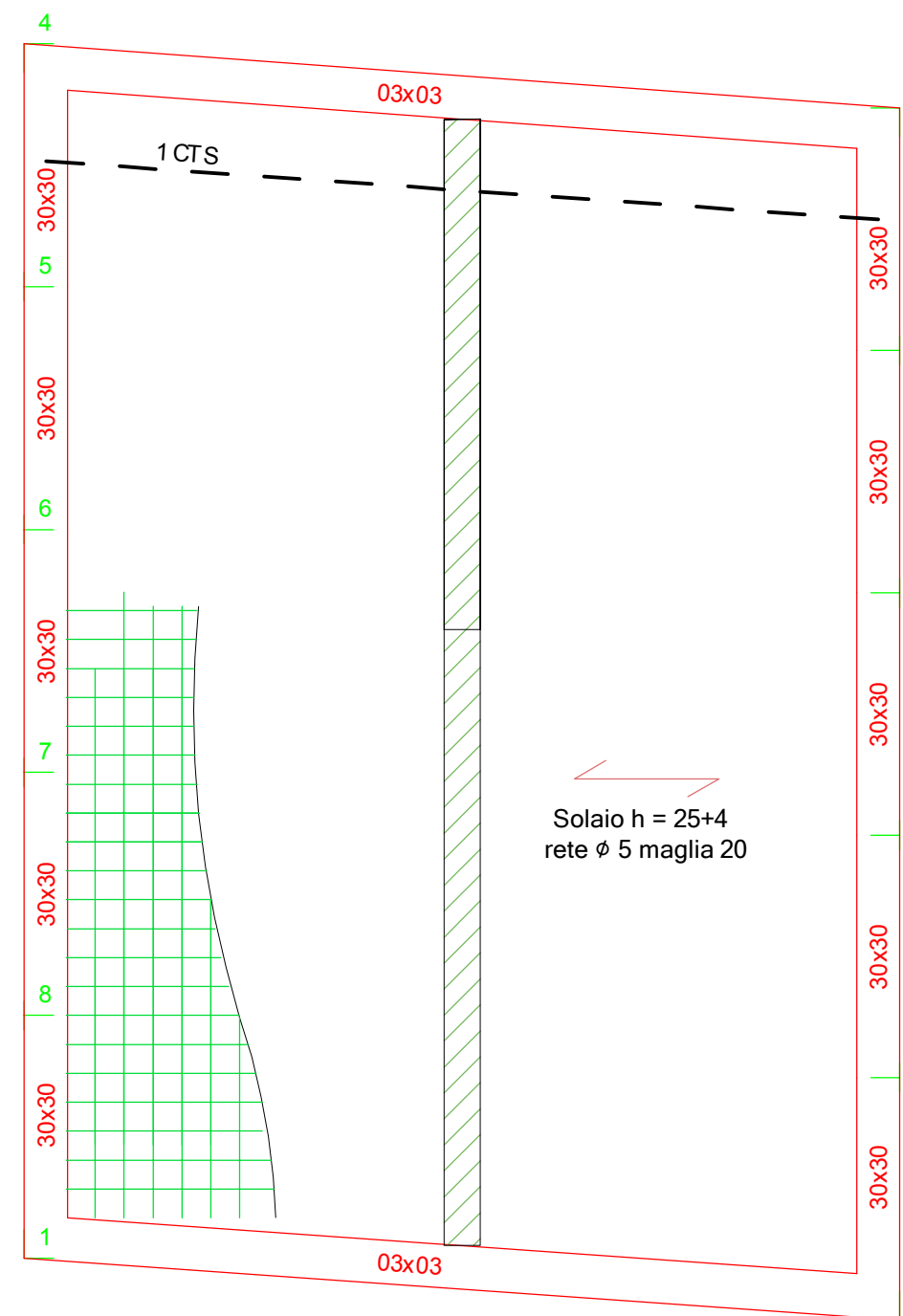

Telaio 1 Piano 1

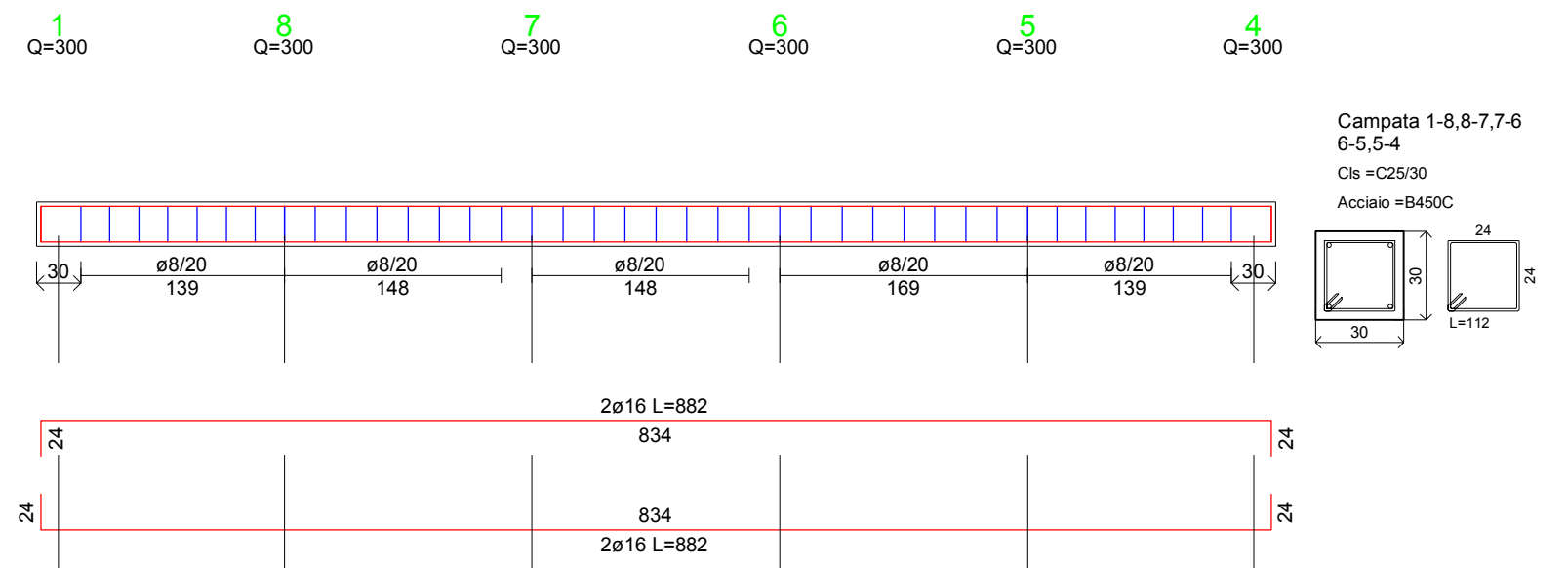

Travata 4 Piano 1

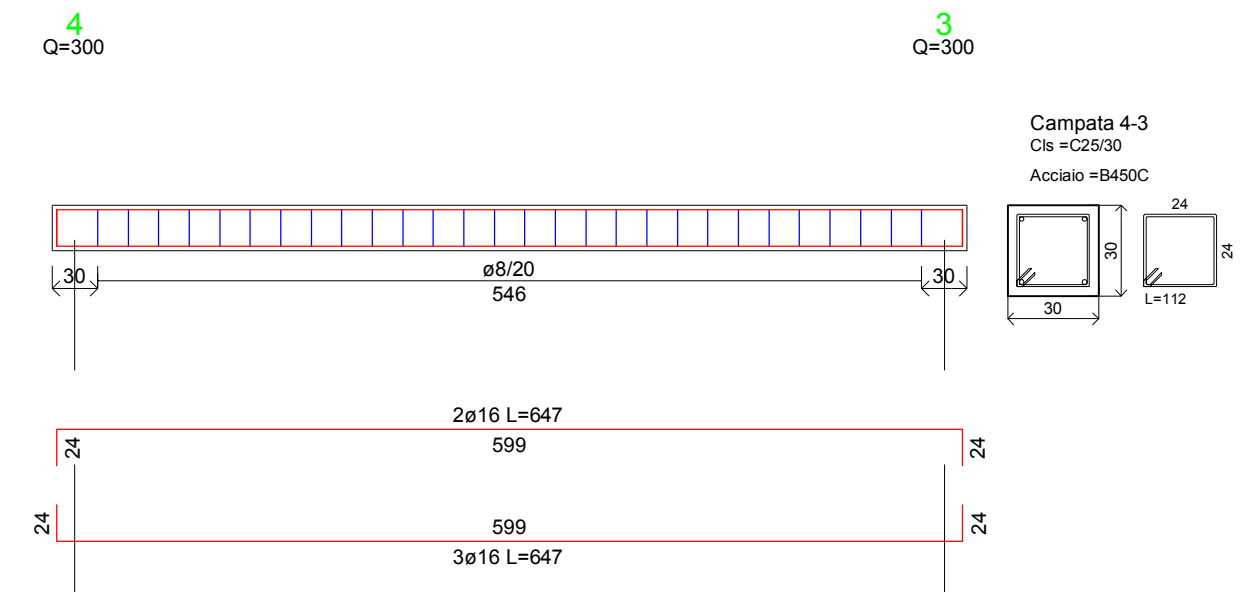

Travata 3 Piano 1

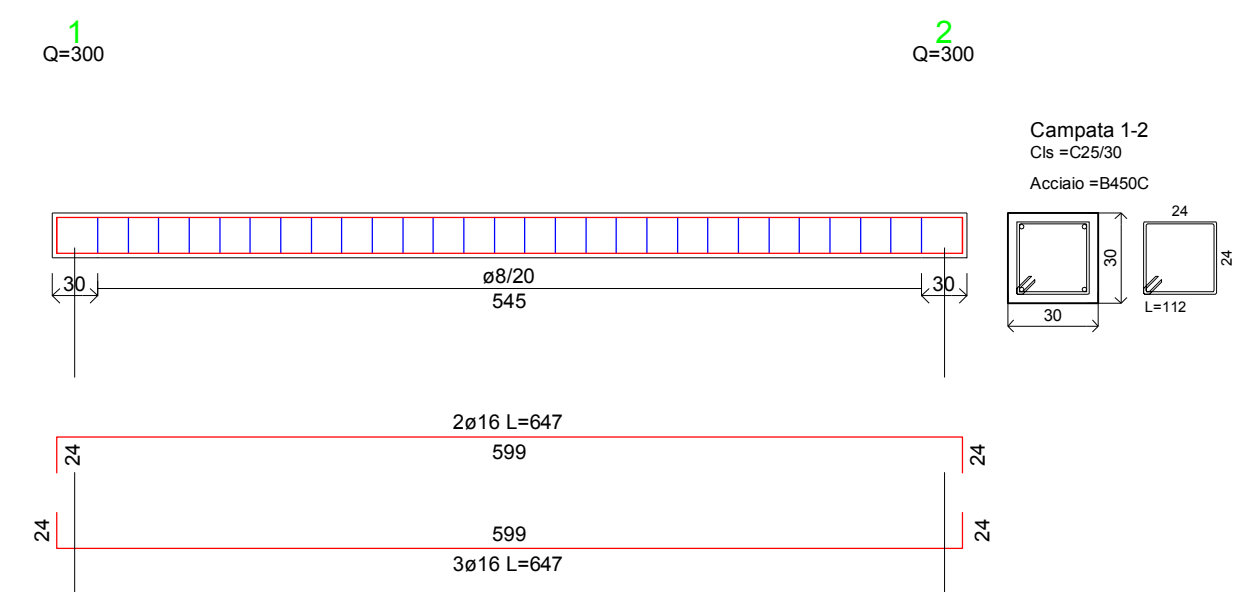

Telaio 2 Piano 1

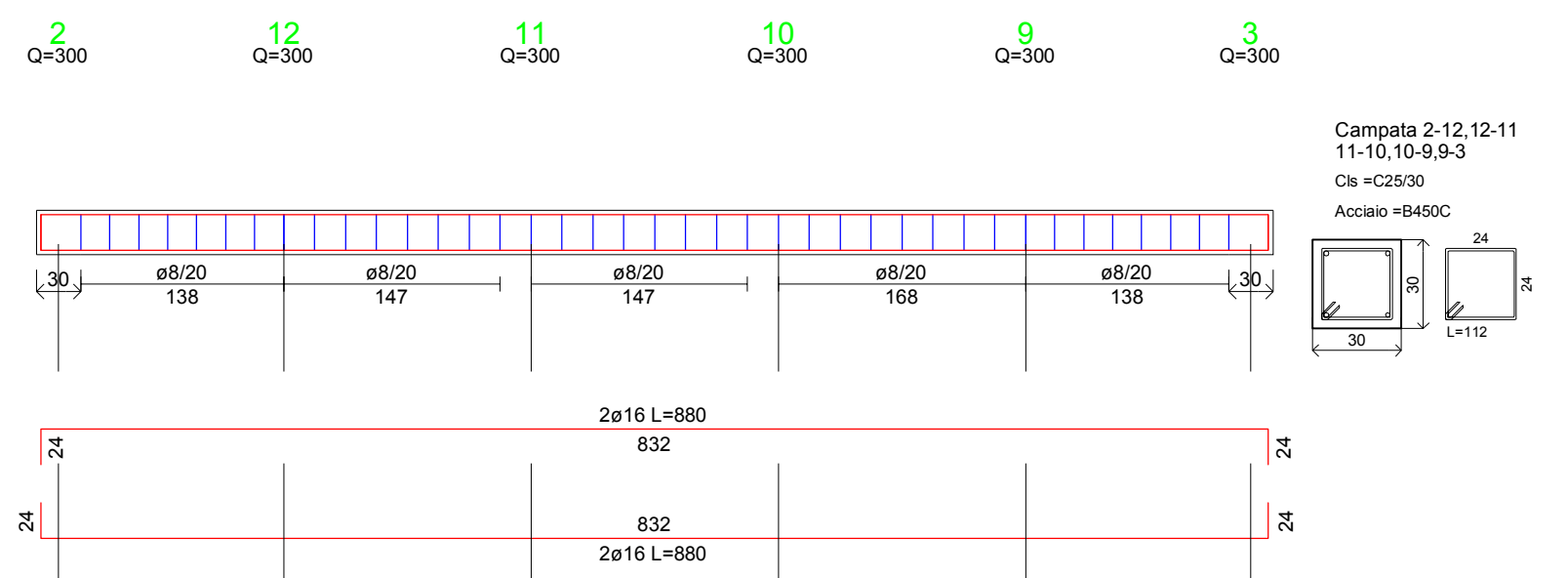

Schema STC1 H=25+4 cm Imp.1

Note: I TRAV. PRECOMP. DOVRANNO PENETRARE NELLE TRAVI DI BORDO PER ALMENO 5 cm.

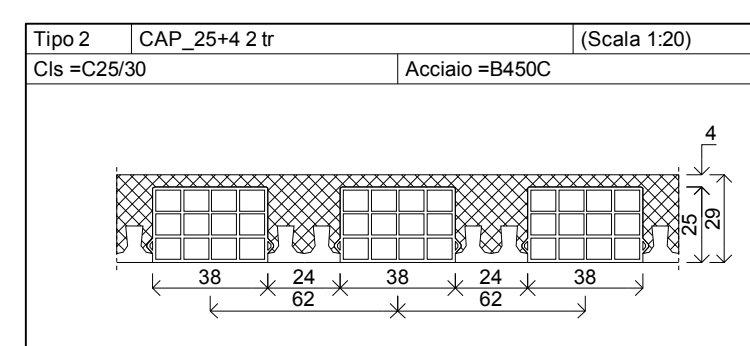
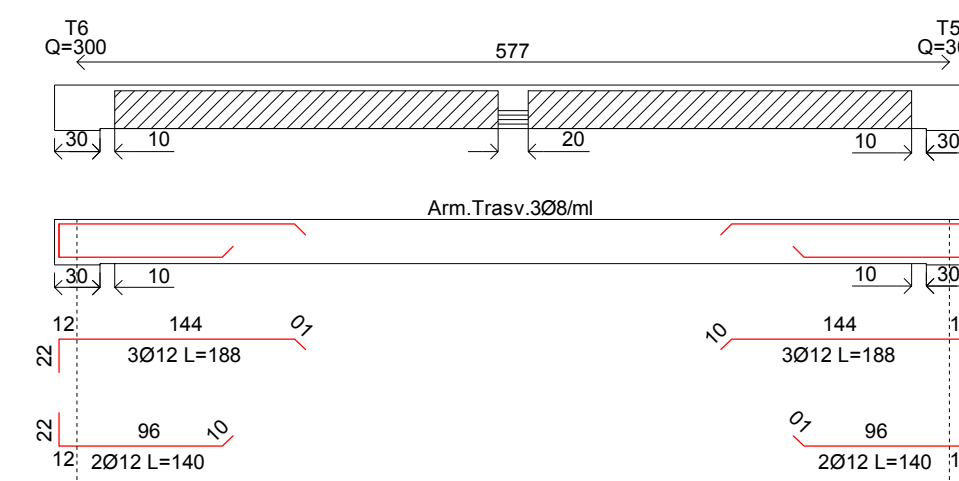

COMUNE DI ORTONA (PROV. DI CHIETI)		IL TECNICO
OGGETTO: LAVORI DI RISTRUTTURAZIONE MERCATO COPERTO		
ESECUTIVI NUOVO SOLAIO ARCHIVIO 02 - RINFORZO 2		
PROGETTO ESECUTIVO		
TAV: B_04	DATA: 29-11-2016	SCALA: 1:50
		ARCH. LUIGI DI MATTEO